

RÁMY / TOKOK
FRAMES

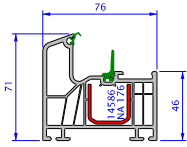

14528 - L 176/FMD

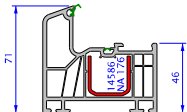

14528 - L 176/FD

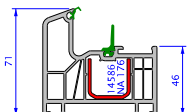

14527 - L 176/MD

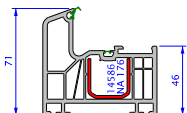

14527 - L 176/D

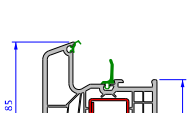

14529 - L 276/GMD

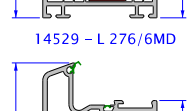

14529 - L 276/6D

ROZŠIROVACÍ PROFILY
TOKTOLDÓ PROFILOK
ADD-ON PROFILES

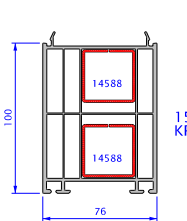

KŘÍDLA / SZÁRNYAK / SASHES

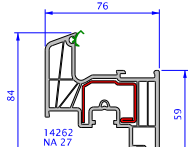

14531 - Z 176/6FD

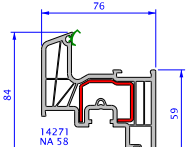

14530 - Z 176/6D

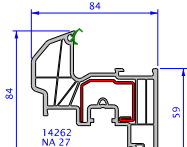

14533 - Z 184/6FD

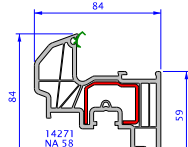

14532 - Z 184/6D

SLOUPKY / OSZTÓK / TRANSOMS

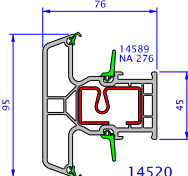

14520 T 276/MD

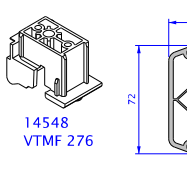

14548 VTMF 276

14507 T 172/D

14551 VTA 172

15934 VTF 172

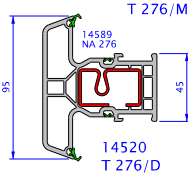

14520 T 276/D

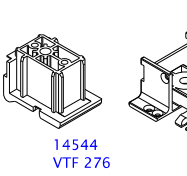

14544 VTF 276

14552 VTA 276

15935 VTS 276

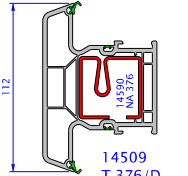

14509 T 376/D

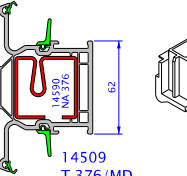

14509 T 376/MD

14545 VTF 376

14553 VTA 376

FALEŠNÉ SLOUPKY / STUPOK
FALSE MULLIONS

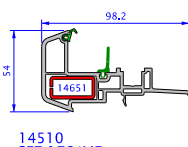

14510 SFZ 176/MD



14777 BS 7

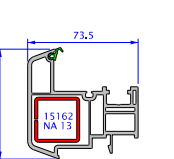

14511 SZ 176/D

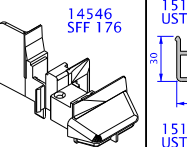

14546 SFF 176



15134 UST 25

15121 KP 12

15130 KP 40

15138 UST 7

15119 KP 9

ROZŠIROVACÍ PROFILY
TOKTOLDÓ PROFILOK
ADD-ON PROFILES 60 mm

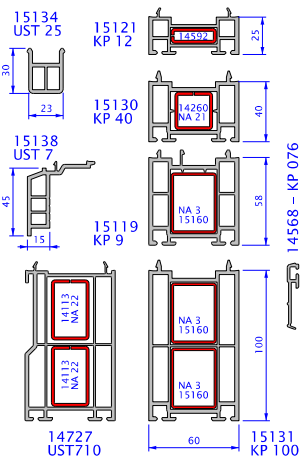

14260 NA 21

14112 NA 22

14113 NA 22

15131 KP 100

14727 UST710

14568 - KP 076

SPOJOVACÍ PROFILY / SOROLÓ PROFILOK
COUPLING PROFILES

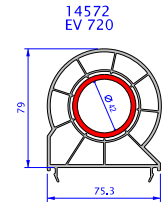

14572 EV 720

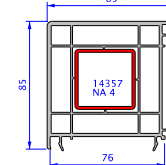

14573 EV 790

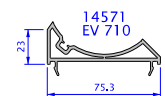

14571 EV 710

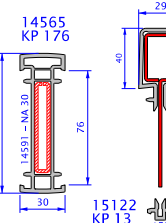

14565 KP 176

14636 KP 14

15122 KP 13

14636 KP 14

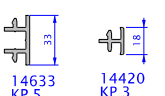

14633 KP 5

14420 KP 3

TĚSNĚNÍ / TÖMÍTÉSEK / GASKETS



14220 DR 10/E

15081 DRF 4/E

14558 DKT 276/E

14179 DL 10/E

14283 FSD 176

14121 DRF 5

15562 DG 11/E

14559 MD 176/E

14575 DRM 176

PODKLADNÍ PROFILY / PÁRKÁNYFOGADÓK / SUPPORT PROFILES

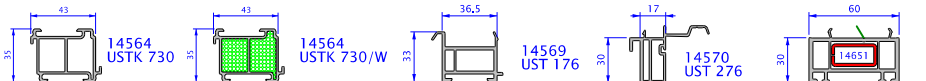

14564 USTK 730

14564 USTK 730/W

14569 UST 176

14570 UST 276

17082 KP 484

ZASKLENÍ / ÜVEGEZÉS / GLAZING

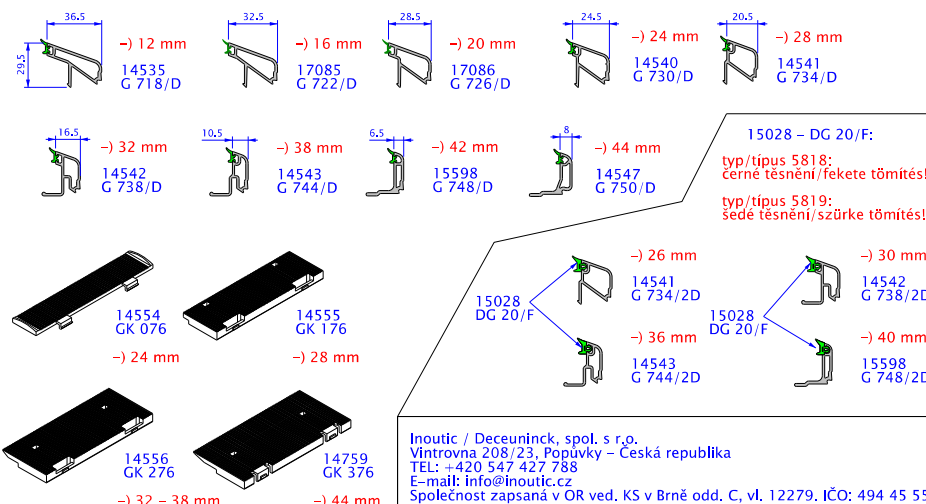

→ 12 mm

→ 16 mm

→ 20 mm

→ 24 mm

→ 28 mm

14535 G 718/D

17085 G 722/D

17086 G 726/D

14540 G 730/D

14541 G 734/D

→ 32 mm

→ 38 mm

→ 42 mm

→ 44 mm

14542 G 738/D

14543 G 744/D

15598 G 748/D

14547 G 750/D

15028 - DG 20/F:

typ / típus 5818: černé těsnění / fekete tömítés!

typ / típus 5819: sedé těsnění / szürke tömítés!

→ 26 mm

14541 G 734/2D

→ 36 mm

14543 G 744/2D

→ 30 mm

14542 G 738/2D

→ 40 mm

15598 G 748/2D

Inoutic / Deceuninck, spol. s r.o.
Vintrovna 208/23, Popůvky - Česká republika
TEL: +420 547 427 788
E-mail: info@inoutic.cz
Společnost zapsaná v OR ved. KS v Brně odd. C, vl. 12279, IČO: 494 45 553